

MODEL AND COMPUTER PROGRAM FOR RADIATION DIMENSIONING AIR HEATERS USED HEATING FURNACES.

DORIAN MUȘAT¹, MIHAI UDRIȘTE¹,
¹UNIVERSITATEA VALAHIA din TÂRGOVIȘTE,

Abstract . This paper presents the mathematical model used in sizing the heat recovery of radiation type heating furnaces equipped room in metallic materials industry. Sizing the heat recovery of radiation type heating furnaces equipped room requires laborious calculations, so that the sizing transcribed mathematical model of radiation heat recovery in a computer program in Microsoft Excel with which checked the sizing recovery heat furnace to heat radiation that equips available in “ Laboratory Termotechnological Aggregates ”in the FIMMR - University of Targoviste Valahia.

With new software, sizing radiation heat recovery becomes easy and fast and requires minimal operator training in programming.

Keywords: size, radiation heat recovery, heating furnace, mathematical model, computer program.

1. INTRODUCTION

In the context of general actions to optimize the specific energy consumption, special attention is given by the steel secondary energy recovery. An important secondary energy source is the natural heat of the exhaust gas evacuated from the heating furnace. These furnaces working at temperatures between 700 - 1400 ° C and heat for preforms future hot deformation.

The most frequent heating furnaces are [1]:

- Hearth furnaces with fixed room;
- Hearth furnaces with room mobile;
- Stepped hearth furnaces;
- Propulsion furnaces;
- Deepest heating furnaces;
- Rotational hearth furnaces stepped.

Exhaust flue gas temperature can achieve temperatures up to 1450 ° C.

Because higher heat losses principally owed to physical heat of exhaust flue gas, furnaces heating efficiency more than 30% and fuel consumption coefficient is between 15-60% [2].

Heat recovery from exhaust flue gas physical heating furnaces can be made in technological direction and energy direction. Recovery technological direction is made by preheating the combustion air by preheating the fuel gas with low calorific value and preheating preforms with ventilator that takes the flue gas after air preheater and send it through some nozzles arranged equidistantly, are obtained speeds of 80 m / s, the cast surface. Recovering energy direction results in the production of heat, usually in the form of steam [3].

Table 1 [4,5] are given roots in key categories of used heat recovery for preheating combustion air with the temperature range of flue gas that can be used.

Table 1. Main heat recovery types used for preheating the combustion air.

Heat recovery		Temperature ranges of the flue gas	Temperatures of the preheated air
Convection recovery	-With plain steel tubes	• 400-900 °C	• 200-600 °C
	-With acicular prominences	• 500-800 °C	• 300-450 °C
Thermo-bloc recovery		700-1150 °C	220-450 °C
Radiation recovery		800-1600 °C	500-800 °C
Mixed recovery		700-1200 °C	500-700 °C

Taking into account low thermal efficiency of heating furnaces, recovery should be made in the technological direction by higher recovery performance, the combustion air to warm to temperatures as high. The integrated steel works, where heating furnaces are supplied with combustible waste gases with low calorific value (mixed with blast furnace gas, coke furnaces gas or natural gas), their preheating becomes economically interesting in special preheaters, located after those combustion air. Preheating the preforms solution is rarely used because of high investment [4].

Lately, most of those engaged in the study of exhaust flue gas heat recovery heat treatment furnace, have reached a common denominator, namely that this recovery is not a collateral part of the technological process itself and must be treated simultaneously with it. For the purposes of this statement, it was found that the heat treatment furnace design take into account the weight of flue gas and heat oven with the delivery itself is also supplied and recovery solution (if I studied recovery of radiation). To reduce losses by sensible heat of combustion is used, mainly, for heat recovery preheating combustion air preheating or material (batch). Recovery performance currently used are quite weak, the low recovery and intense degradation during operation. Therefore modernization trends recuperators were to obtain high temperature air preheating and / or combustible gases, simple construction to be energy efficient and low cost price.

Most times these objectives required by the recovery may not meet a common ground because, for example high temperature preheating leads to increasing surface heat exchange, so increasing the price of investment (for each 100 ° C increase in temperature air preheating is necessary to double heat transfer surface). Also, increasing the preheat temperature increases the temperature to which they are subject to various components of the system, increasing the risk areas most requested destruction of thermally. Another drawback is the mechanical tensions faced by equipment, because appearance different thermal expansion of component parts.

Heat recovery systems are heat transfer equipment that transmit heat from one environment to another by contact with the wall separating the different faces. Heat transfer between the two areas is the wall that separates them. Heat transfer always occurs, the second principle of thermodynamics, the hotter medium in the cold. Heat transfer is stationary in time (continuously).

Radiation recuperators are made, in principle, the two metal tubes (interior and exterior), relatively large diameter, arranged concentrically, which are linked together by an elastic expansion compensator. Flue gas flows through tube inside, resistance gazodinamique inserted is negligible [4]. In fig.1 [5] is shown schematically a simple recovery radiation.

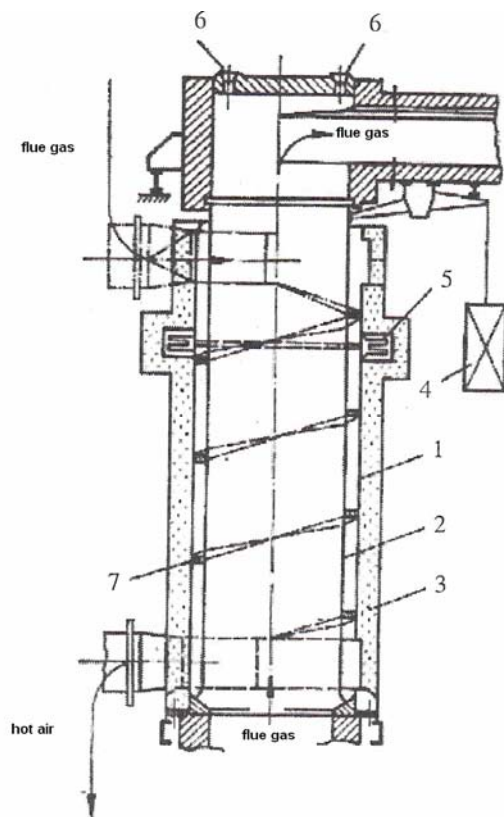

Fig. 1. Simple radiation recovery (unilateral)
 1-outer shell ring; 2-inside shell ring; 3- insulation;
 4- counterweight; 5-compensatory expansion;
 6-access cover; 7-helical ribs

Flow of two fluids (air and flue gas) by radiation recuperator is made in the same direction (echicurent) fig. 2a or opposite direction (countercurrent) fig. 2b [6].

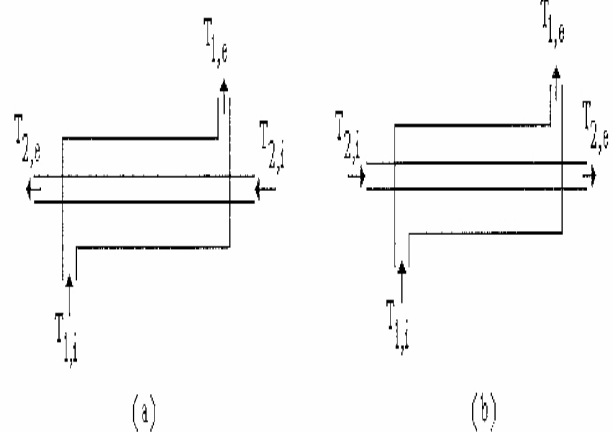

Fig. 2. Flow diagram of the two fluids
 a-echicurent flow; b-flow countercurrent

The radiation recuperators heat flux density reaches maximum:

$$q_{max} = (58...93) \cdot 10^3 \text{ W/m}^2$$

Constructive form of radiation recuperators has suffered substantial changes because of the possibility to obtain fire-resistant steels at temperatures of 1100°C, no oxidation or creep. t was so combustion air temperature to reach values of 950-1100°C, for a flue gas temperature entering the recovery of 1650°C. Unilateral radiation recuperators were the main disadvantage limited heat exchange surface. To remove this inconvenience and have developed bilateral radiation recuperators (fig. 3) [6], recuperator hourglass with two roads on the air (fig.4 a) and recovery of radiation with two roads on the flue gas (fig. 4, b) [6].

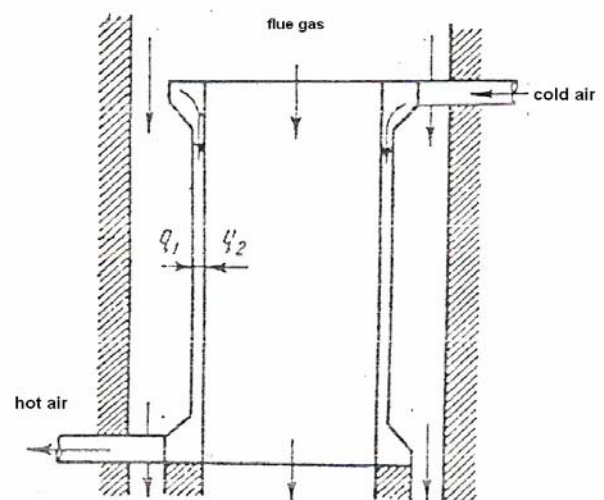

Fig. 3. Recovery with bilateral radiation

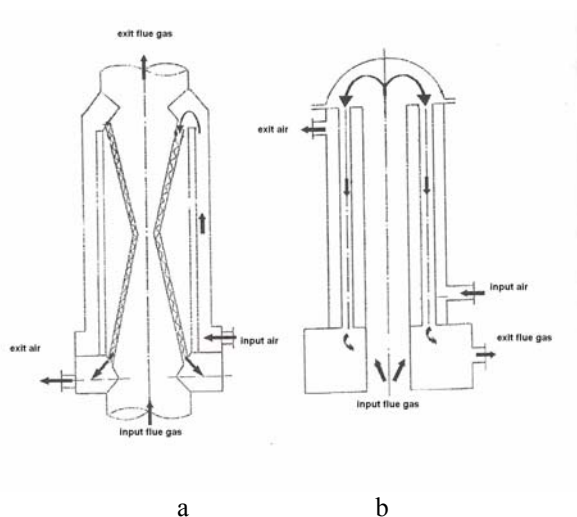

Fig.4. Recovery of radiation with two roads a-hourglass-type, b- with two roads on the flue gas

Today most experts agree that physical recovery of the flue gas heat evacuated from industrial installations is not an addition to the technological process itself, but must be treated simultaneously and in direct correlation with this. This statement is supported by the current method to design, build and deliver complete equipments beneficiaries, which includes a whole and physical heat recovery equipment for flue gas evacuated from these equipments.

2. MODEL OF RADIATION FOR DIMENSIONING RECUPERATORS

Radiation heaters are heat recovery equipment removal from flue gas heating furnace room type metallic materials industry, where the flue gas temperature and reach values between 1100°C -1250°C.

To achieve maximum efficiency physical gas fired heat recovery should the flue gas velocity of radiation passing through the preheater to be between 0.5 m / s and 5m / s and passing through speed combustion air preheater of radiation to be values between 20 m / s and 50m / s, values to be observed for all the operation of heating furnaces.

Mathematical model for sizing radiation heaters was designed to achieve maximum efficiency physical gas fired heat recovery evacuated throughout the operating range of the heating furnace. For various operating modes the furnace, the mathematical model takes into account the appropriate values: fuel flow, DC, nature and composition of the fuel evacuated from furnace flue gas temperature, TGI, coefficient excess air out of the furnace, α_i , coefficient of excess air into the combustion plant, α , air temperature entering the preheater, TAI. Also are introduced and other input quantities, derived from the preheater design choice, such as:

$\Delta\alpha$ - The amount by which excess air ratio increases.

TAE [°C] - The air temperature at the exit of preheater.

η - Preheater efficiency.

ε - Emission coefficient of the wall.

p_G [bar] - Pressure preheater flue gas at the entrance.

G [m] - Plate thickness of which is made preheater.

Same as input is entered and flow diagram of the two fluids (echicurent, countercurrent).

First mathematical model calculates air flow and flue gas from entering the preheater, DAI respectively DGAI in [m^3_N air /h] respectively [m^3_N flue gas /h], then determines the amount of heat continues to enter the air preheater, QAI and amount of substances contained in flue gas heat from entering the preheater, QGI in [W].

Flue gas temperature at the exit of preheater, TGE, is determined by successive approximations describing energy balance relationship of the two fluids, taking account of heat losses ceded environment and temperature of combustion air preheating, TAE.

Flow diagram of the two fluids is calculated logarithmic mean temperature difference, ΔT_{MED} and mean temperatures of air and flue gas TMA, TMG. Calculate the equivalent hydraulic diameter and flow speed sections and fluids.

Convection coefficient for air and gas that is calculated criterial relations invariable value data by Reynolds, flow type, etc..

Gas radiation coefficient is calculated from the relationship Stephan - Boltzmann with emissivity coefficients, which are based on the average temperature of gases, the product of the pipe wall and gas partial pressure and film thickness triatomics gas.

Required heat exchange surface is determined based on overall heat transfer coefficient and compared with surface heat exchanger geometry chosen, until the changes in geometry recovery, reaching a maximum difference of 0.3%. Finally the machine length is calculated from [m] depending on heat flow from gas FTGA [W/m^2], heat flow from the air, FTA [W/m^2] and quantity of heat taken from air, QA [W].

The sizing algorithm mathematical model of convection heaters shown in fig. 5.

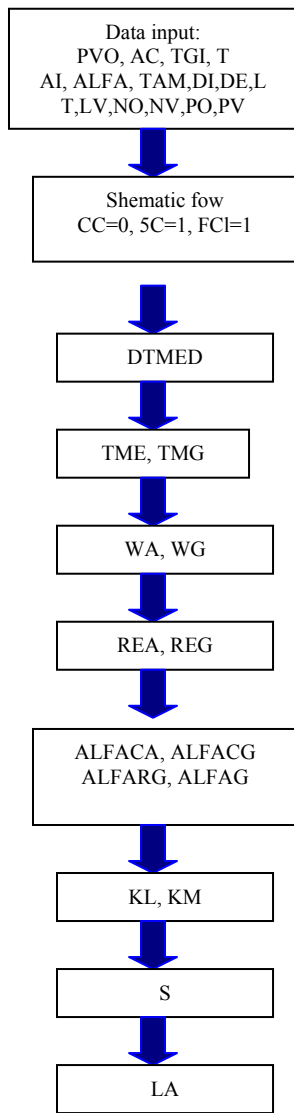

Fig.5. The scheme calculation algorithm

3. COMPUTER PROGRAM FOR DIMENSIONING RADIATION RECUPERATORS.

Computer program was sizing of air preheater radiation that equips a forge furnace.

To run the software for various operating regimes of the forge furnace, gas flow data, temperature and composition of the exhaust flue gas from the furnace. Maximum preheat temperature was imposed by the combustion plant, being TAE = 270°C.

Figures 6, 7, 8, 9 and 10 are shown graphical interfaces, made in EXCEL, a program designed for sizing air preheater radiation that equips a forge furnace.

A. CALCULUL PARAMETRILOR INTRARE-IESIRE			
a. GAZE ARSE			
INTRARE RECUPERATOR			
Temperatura gazelor arse la intrarea in recuperator	TGI	1000	°C
Debitul combustibil	DC	57	m³/h
Coefficientul de exces de aer	ai	1.05	
IESIRE RECUPERATOR			
Valoarea cu care creste coeficientul de exces de aer	Ja	0.05	
b. AER			
INTRARE RECUPERATOR			
Temperatura aerului la intrarea in recuperator	TAI	20	°C
Coef. de exces de aer in instalatia de ardere	a	1.2	
IESIRE RECUPERATOR			
Temperatura aerului la iesirea din recuperator	TAE	270	°C
c. Randamentul recuperatorului			
	η	0.98	
d. Coeficientul de emisie al peretelui			
	ε1	0.9085	
	εe	0.9187	
e. Presiunea gazelor			
	PG	1	bar
f. Grosimea tablei			
	G	0.005	m
A.2.CALCULUL PARAMETRILOR INTRARE-IESIRE			
a. AER			
Volumul real de aer	Vreal	11.89127314	m³/aer/m³gaz
Debitul de aer	DAI	977.802369	m³/h

Figure 6. Graphical interface1, made in EXCEL, a program designed for sizing air preheater radiation that equips a forging furnace.

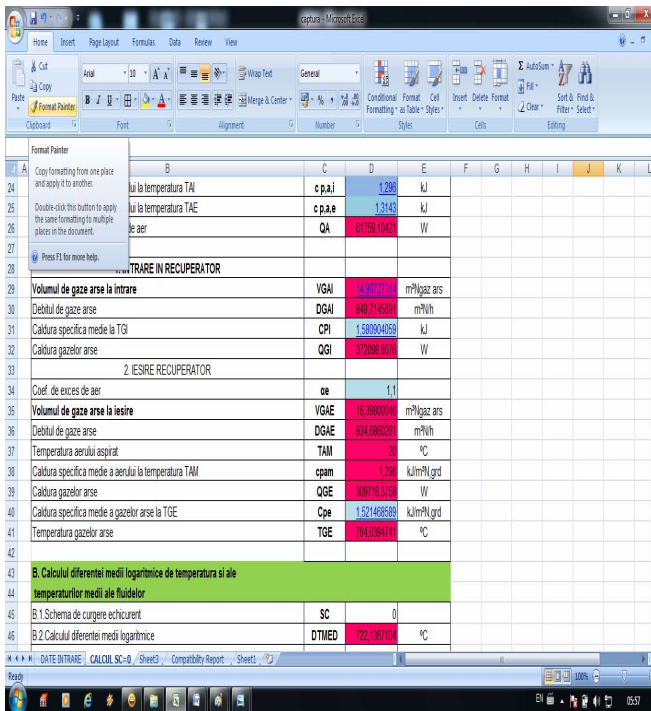

Figure 7. Graphical interface 2, made in Excel, a program designed for sizing air preheater radiation that equips a forging furnace.

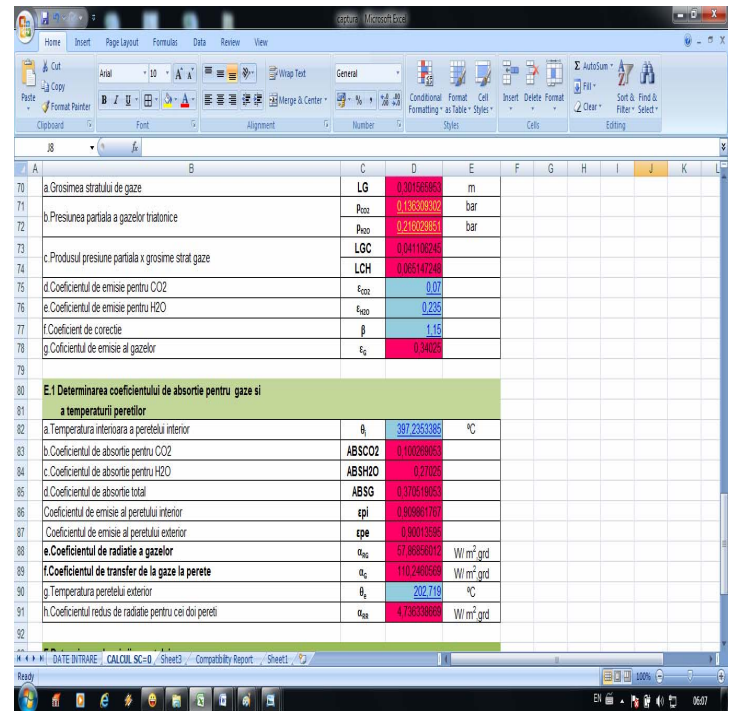

Figure 9. Graphical interface 4, made in Excel, a program designed for sizing air preheater radiation that equips a forging furnace.

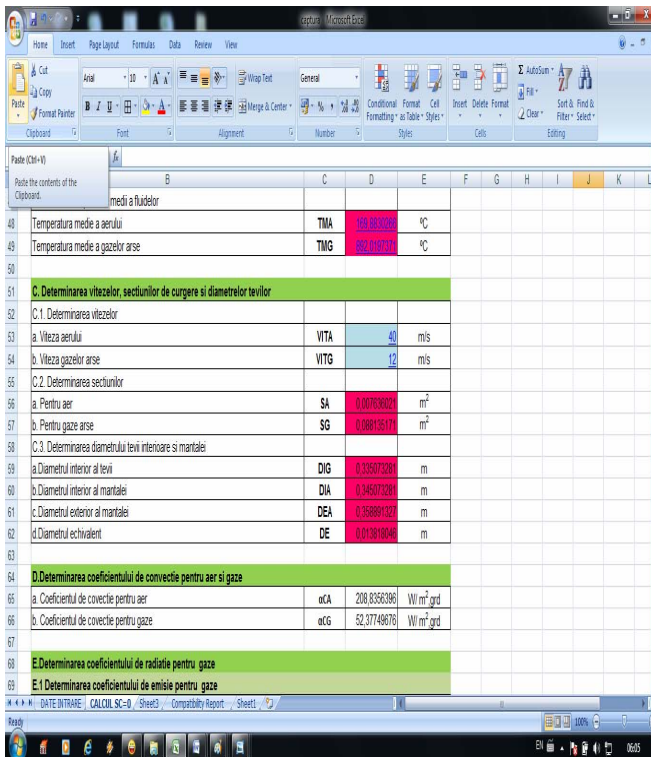

Fig. 8. Graphical interface 3, made in EXCEL, a program designed for sizing air preheater radiation that equips a forging furnace.

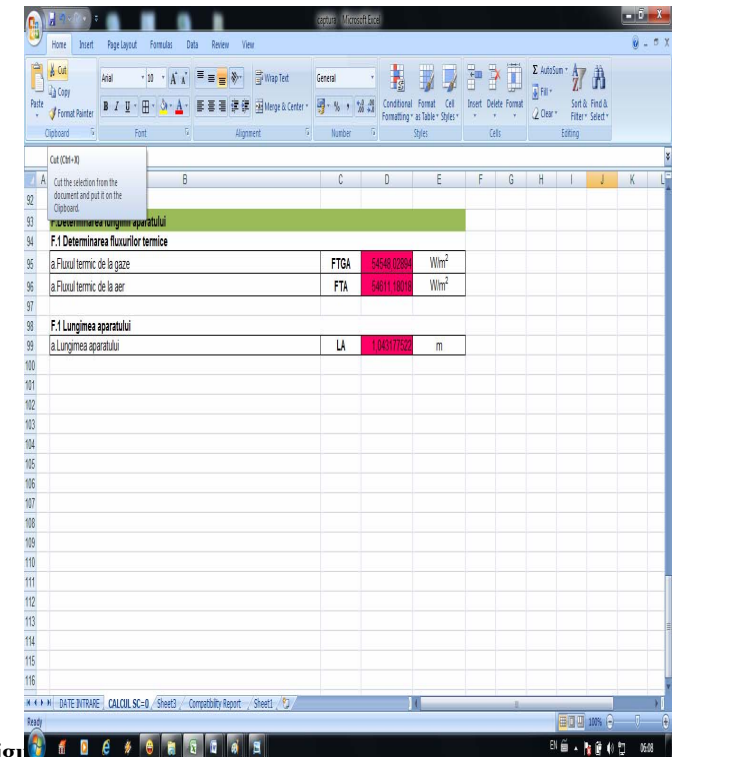

Fig. 10. Graphical interface 5, made in EXCEL, a program designed for sizing air preheater radiation equips a forging furnace.

4. MATHEMATICAL MODEL VALIDATION AND COMPUTER PROGRAM

Validation of mathematical model and computer program was made in Laboratory Termotehnological Aggregates University of Targoviste Valahia, laboratory equipped with a heating furnace equipped with a heat recovery from radiation-size table 2. Heating furnace shown in Figure 11 is equipped with a pulse burner PYRONICS, tip 601 NM with consumption schedule / pcs of 25Nm³/h.

Automatic driving system for heating furnace made the following functions:

- preventilare;
- ignition and flame supervision with UV cell;
- continuous adjustment of the load while maintaining constant air-fuel ratio;
- stable operation of the burners in the minimum-maximum;
- measurement and indication of functional parameters;
- automatic management of the combustion process by using a temperature programmer-controller high quality and reliability.



Fig. 11. Furnace Heating

Was heated furnace until the flue gas temperature at the exit from recovery TAE reached 1000⁰C and combustion air temperature measured at the entrance of recovery, respectively out of recovery. Temperature combustion air from entering the recovery TAI has value 20⁰C, and combustion air temperature at the exit from recovery TAE had value 260⁰C.

Data from testing done on the heating furnace and the data obtained from computer program is introduced in Table 2 for comparison.

Table 2. Comparison of calculated elements with those derived from experimentation.

Compared elements	Existing values	Values calculated	The difference [%]
Internal diameter of pipe [mm]	330	335.07	1.6
Diameter outside of the pipe [mm]	340	345.07	1.5
The inner diameter of the mantle [mm]	360	366.93	1.9
The machine length [mm]	1000	1043	4.2
TAI [⁰ C]	20	20	0
TAE [⁰ C]	260	270	3.7

4. CONCLUSIONS

This computer program was used for sizing an air preheater the flue gas heat recovery physical evacuated from a heating furnace.

Making mathematical model for sizing and translating it into a Microsoft Excel software and its ease of access, allowing technicians to construction materials and dimensional metallic radiation recuperators alone that equips heating furnaces.

Values obtained from the computation of realized with the software are very similar to those obtained from experimentation made in the laboratory.

5. REFERENCES

- [1]. Brunklaus, J.H., *Industrial furnaces*, Bucuresti, Ed. Tehnica 1977.
- [2]. Mediokritskii, E.I., Gaponov, V.I., Loginov, V.E., *Journal of Engineering Physics and Thermophysics*, Vol. 70, No.1, 1997.
- [3]. Gaba, A., *Considerations of physical heat recovery furnace flue gas evacuated deep Energetica*, Vol.38, No. 3-4, 1990.
- [4]. Popa, B., s.a., *Industrial heat exchangers*, Bucuresti, Editura Tehnică 1977.
- [5]. Ghia, V., *Recuperateurs et regenerateurs de chaleur*, Ed. Eyrolles, Paris, 1978.
- [6]. Badea, A., s.a., *Thermal equipment*, Bucuresti, Ed. Tehnica 2003.