

## RESEARCH WORK AND STUDY ON ULTRAPRECISE HIGH-TECH ROBOTIC MICRO-NANO-SYSTEMS FOR MEASUREMENT, POSITIONING AND ALIGNMENT USED IN THE FIELDS OF MECHATRONICS AND INTEGRONICS

Istrițeanu S.<sup>1</sup>, Gheorghe<sup>1</sup> I. Gh.

<sup>1</sup>INCDMTM Bucharest, Romania, simona.istriteanu@incdmtm.ro, incdmtm@incdmtm.ro

**Abstract:** The scientific paper presents a structural, functional and performance study on a wide range of ultra high-tech robotic micro-nano-systems for measurement, positioning and alignment to optimize constructive solutions for applications in the field of Mechatronics and Integrionics for technical, technological, industrial and precision nanoscale metrology processes.

**Keywords:** robotic micro-nano-systems; measuring; positioning; aligning; nanometric processes.

### 1. STUDY ON HIGH-TECH MEASUREMENT, POSITIONING, CONTROL AND ADJUSTMENT ROBOTIC MICRONANOSISTEMELE

**1.1. Robotic, micro and nano-robotic MEMS&NEMS** ensure future development and evolution of technologies, micro and nanotechnologies, as follows: micro-systems and technologies for nano-positioning, principles and concepts in "hybrid system specifically for systems and micro and nano-scale technologies", virtual technology platforms for smart and completely automated manufacturing, cutting-edge software for micro and micro and nano-displacements and nano-positioning; e advanced micro-nano-machining hardware; internal architecture controllers providing hyper-intelligent digital signal processing, advanced mechatronic applications for Industry, Biology and Medicine.

### 1.2. High-tech robotic micro-nano-systems for measuring, positioning, control, adjustment and calibration

#### 1.2.1. Cartesian Nano-manipulator of nanometer resolution, shown in Figure 1.



Fig.1

Technical and functional characteristics:

- displacement increment: 0.4 nm;
- work range: IO 100 mm;
- work speed: 2000 um/s;
- displacement: continuous or in paces;
- maximum speed acceleration time: 0,3 ms;
- response time: 10 ms;
- nano-positioning and nano-displacement: ideal;
- controller: high accuracy multi-channel.

The nano-mechatronic resolution Chartesian nano-manipulator, is made up of modular/standard units, such as the linear module of transfer of linear displacement on an interval, with ultra-high stability and the linear

module of transfer of linear displacement on a small interval, with ultra-high stability and the linear module of transfer of linear displacement on a large interval (fig. 2).



Fig. 2

#### 1.2.2. 6 axes micro-robotic system for complex alignments with high micro-nano-positioning accuracy (fig. 3):



Fig. 3

Technical and functional characteristics:

- parallel kinematic structure: with 6 orientations;
- actuators with the resolution of: 0,033 nm;
- replicability in space: 0,3 nm;
- kinematic system: serial compact and with good dynamics; precise scanning and aligning;
- visualization of points: main, with the control of Chartesian coordinates;
- controller: digital, with LabView;
- routines: of aligning, integrated;

Applications of this system with 6 axes are: micro-robots, micro-actuatings, micromanipulation, optical test equipment, alignment / positioning MEMS &NEMS.

#### 1.2.3. 6 axes micro-robotic «Hexapode with 6 axes, parallel kinematics» (fig. 4):



**Fig. 4**

Technical and functional characteristics:

- controller: high speed;
- orientation: in plane and space;
- capacity (vertical): 200 kg;
- resolution: ultra-high;
- replicability:  $\pm 1 \mu\text{m}$ ;
- transducer resolution:  $0,005 \mu\text{m}$ ;
- scanning: multi-axes, linear and rotation;
- virtual pivot points;
- algorithm: sophisticated for the controller; -MTBF: 20.000 h.

**1.2.4 Piezoelectric aligning micro-system (fig. 5):**



**Fig. 5**

Technical and functional characteristics:

- x, y, z: monitored (piezoelectric engine);
- interval: 15 mm;
- resolution: 1 nm;
- transducer: piezoelectric, with ultra-precise resolution;
- variants: 8 types;

Typical applications of the piezoelectric system alignment are testing devices, alignment / positioning; micro-actioning, MEMS&NEMS, micromanipulation; semiconductor systems test.

**1.2.5. 3 axes nano-manipulator for micro-nano-positioning (fig. 6):**



**Fig. 6**

Technical and functional characteristics:

- range: 10 mm;
- resolution xyz:  $< 0,4 \text{ nm}$ ;
- variable speed:  $0,5 \text{ nm/sec.} + 500 \mu\text{m/sec.}$ ;
- controller: programmable;
- applications: micro-nano-positioning control;
- motorisation: piezoelectrical;
- angular resolution:  $5 \mu\text{rad/sec}$ .

**1.2.6. 3 axes nano-manipulator— new generation**



**Fig.7**

Technical and functional characteristics:

- range: 10 mm;
- resolution xyz:  $0,4 \text{ nm}$ ;
- linear increment:  $< 0,4 \text{ nm}$ ;
- thermal variation:  $< 2 \text{ nm/h}$ , la  $20^\circ\text{C}$ ;
- bi-directional replicability:  $< 0,5 \mu\text{m}$ ;
- histerezis:  $< 0,5 \text{ nm}$ ;
- $0x/\text{lmm}$ :  $< 25 \mu\text{rad}$ ;
- $0y/\text{lmm}$ :  $< 25 \mu\text{rad}$ ;
- $0z/\text{lmm}$ :  $< 25 \mu\text{rad}$ ;
- maximum speed:  $500 \mu\text{m/sec}$ ;
- reaction time:  $< 0,3 \text{ msec}$ ;
- speed range:  $0,5 \text{ nm/sec} + 500 \mu\text{m/sec}$ ;
- response time:  $10 \mu\text{m}$ ;
- acceleration:  $0,5 \text{ m/sec}^2 * 5 \text{ m/sec}^2 / 0,5 \mu\text{m} \ 5 \mu\text{m}$ ;
- capacity: 3 kg;
- push/pull force: 15/50 N;
- lateral force: 100N; tension: 12 V; consumed power: 1 W; dimensions: 198 x 123 x 115 (mm).

**1.2.7 Nano-manipulator Micro-Nano-System (fig. 8):**

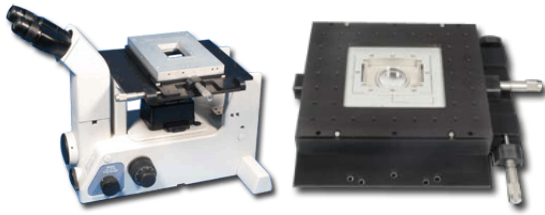

**Fig. 8**

Technical and functional characteristics:

- work range:  $3+15 \text{ mm}$ ;  $10+25 \text{ mm}$ ;
- rotation in the vertical plane:  $90^\circ$ ;
- rotation in the horizontal plane:  $360^\circ$ ;
- mounting: on the microscope;
- software: programmable control;
- increment: 1 nm; 4 nm;
- resolution:  $0,4 \text{ nm}$ ;  $4 \text{ nm}$ ;
- thermal variation:  $< 2 \text{ nm/h}$ , at  $20^\circ\text{C}$ ;
- single direction replicability:  $< 0,4 \mu\text{m}$ ;  $4 \text{ nm}$ ;
- two directions replicability:  $< 0,5 \mu\text{m}$ ;  $5 \text{ nm}$ ;
- histerezis:  $< 0,5 \mu\text{m}$ ;  $5 \mu\text{m}$ ;
- speed range:  $0,5 \text{ nm/sec} + 500 \mu\text{m/sec}$ ;  $5 \text{ nm/sec} + 5 \mu\text{m/sec}$ ;
- reaction time:  $< 0,3 \text{ msec}$ ; response time:  $10 \mu\text{m}$ ;
- acceleration:  $0,5 \text{ m/sec}^2 \ 5 \text{ m/sec}^2 / 0,5 \mu\text{m} + 5 \mu\text{m}$ ;
- capacity: 3 kg; 6kg;
- push/pull force: 15/50 N; lateral force: 100N;
- tension: 12 V; consumed power: 1 W;
- dimensions: 198 x 123 x 115 (mm).

**1.2.8 Micro-nano-positioning Nano-view Micro-Nano-System (fig. 9)**



**Fig.9**

Technical and functional characteristics:

- axes: XY or XYZ;
- XYZ range: 100  $\mu\text{m}$ ; 200  $\mu\text{m}$ ;
- resolution: 0,2/0,4 nm;
- frequency on X: 450/400 Hz  $\pm$  20%;
- frequency on Y: 350/300 Hz  $\pm$  20%;
- frequency on Z: 450/350 Hz  $\pm$  20%;
- $\theta_{\text{roll}}, \theta_{\text{pitch}} < 1 \text{ Fad}$ ;  $\theta_{\text{yaw}} < 3 \mu\text{rad}$ ;
- capacity: 0,5 Kg;
- basic material: Al. Invar or Titanium.

**1.2.9. Other examples of «Hexapodetic robots»** for displacements and positioning in space, realized in innovative constructions (fig. 10):



**Fig. 10**

**2. STUDY ON FLEXIBLE MECHATRONIC ROBOTIC SYSTEMS**

**2.1. Integrated intelligent robotic control systems:** engineering technology systems are increasingly developed intelligent, flexible robotic systems for in-process service, centres, systems, flexible production lines and workshops, to ensure continuity in manufacturing processes of complex industrial parts and

small parts, medium and large parts, in various industrial environments.

The integration of flexible robotic systems into the flexible production includes a structural and functional implementation, as a technological system and the implementation as command and leadership functions, as an information and informative system in a systematic collaboration of information transfer, processing information and processing information into the command and management of the integrated production. Out of the flexible robotic systems currently in use are identified, integrated into control systems and integrated control robotic machines (fig. 11; fig. 12; fig. 13).

**3D Control robots + 2 $\phi$ :**



**Fig. 11**

**3D Control robots: 3D + 1 $\phi$ :**



**Fig. 12**

**Control robot, integrated into the fabrication line:**

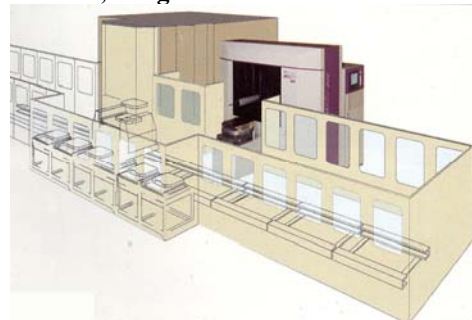

**Fig. 13**

**2.2. Intelligent robotic mechatronic equipments, in the serial production**

**2.2.1 3D Intelligent robotic mechatronic equipments, in the serial production (fig. 14)**

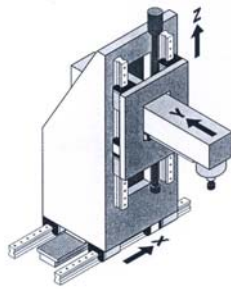

Fig. 14

**2.2.2 3D Intelligent robotic mechatronic equipment for the control of fabrication in mechatronics (fig. 15)**

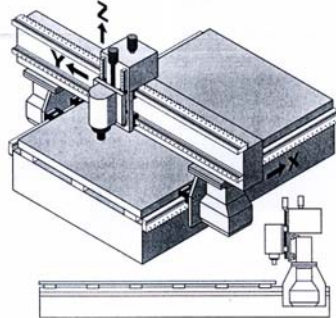

Fig. 15

**2.2.3 Intelligent mechatronic robotic centre for micro-processing in the mechatronic industry (fig. 16)**

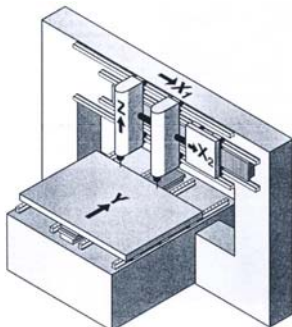

Fig. 16

**2.2.4 Intelligent mechatronic robotic system for electronic component investigation (fig. 17)**

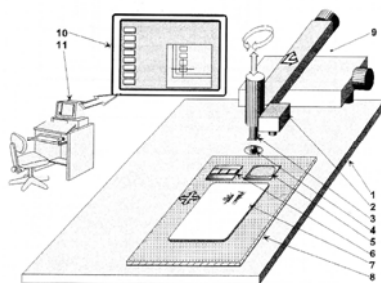

Fig.17

**2.3. Mechatronic robotic micro-equipments for intelligent measuring in coordinates.**

**2.3.1 Mechatronic robotic micro-equipments of measuring in coordinates with parallel mechanism (fig. 18).**

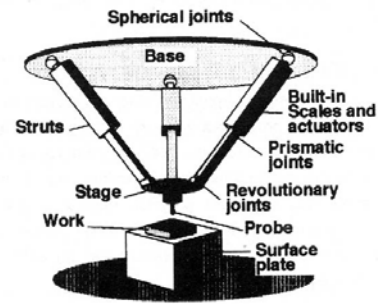

Fig.18

**2.3.2 Mechatronic robotic octoedral micro-system for intelligent measuring in coordinates with parallel mechanism (fig. 19)**

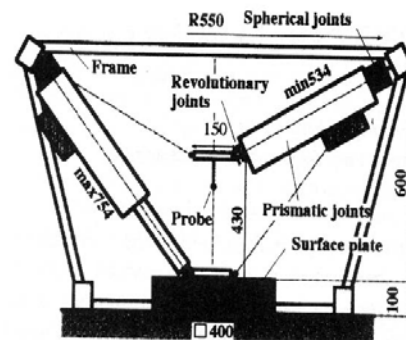

Fig.19

**3. STUDY ON INTELLIGENT MICRO-NANOROBOTIC TECHNIQUES AND TCEHNOLOGIES**

**3.1 Intelligent Micro-Nano-Robotic Techniques and Technologies**

Micro-Nano-Robotics, in its evolution, develops, in accordance with the progress of micro-nanotechnologies and micro-nano-materials, predicting a "human anatomy Micro-Nano-Robotics and creating the future "humanoid population and new society. "

Micro-control for position nano-manipulation and / or micro-nano scale force is the solution that enables new techniques for micro-nanotechnologies, by filling the space between "tip-bottom and bottom-top strategies" and lead to the emergence of molecular assemblies based on replication. These types of complexes have been proposed as general purpose micro-nano-mechatronic devices for manufacturing a wide range of useful products as well as copies (self-replication). Currently, micro-nano-manipulation can be applied to the scientific exploration of microscopic, physical, and biological phenomena and builds new prototype micro-nano-devices.

STM micro-nano-manipulation developed by the invention of the atomic force microscopes (AFM) and other types of sample scanning microscopes (SPM). In addition, optical tweezers (laser tubes) and magnetic tweezers, micro-nano-manipulators are also possible. Micro-nano-robotic manipulators ( $\mu$ nRMs) are characterized by the capability of 3D positioning, orientation control, and the ability to independently

activate multiple effectors and independent observing systems in real time and can be integrated with the sample scanning microscopes. Micro-robotic manipulators extend very much the complexity of the process of nano-manipulation. A brief comparison of STM, AFM and NMR technologies is shown in figure 20

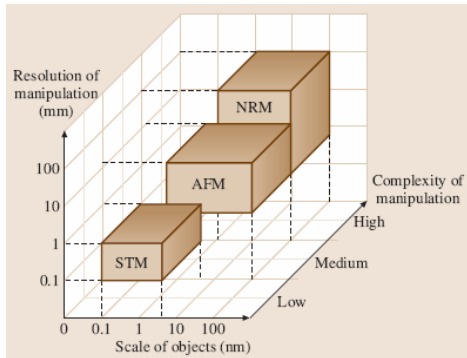

Fig. 20

An AFM is another type of micro-nano-manipulator. There are three modes of AFM image, respectively the contact, the binding mode (regular contact mode) and non-contact mode. The last two modes are so-called dynamic and capable of a higher resolution than contact mode. Atomic resolution is achievable with non-contact mode. Handling can be done with an AFM contact mode or dynamic mode.

In general, an AFM manipulation involves moving an object by tapping it with a spike. A typical manipulation is a particle image in the first non-contact mode, then removing sweeping oscillations and peak over peak particles in contact with the surface and with the weaker reaction.

Pushing can exert greater mechanical forces on objects and it can be used to handle larger objects. 1D and 3D objects can be handled on a 2D substrate. However, the manipulation of individual atoms with an AFM remains a challenge. The separation of image making and handling nano-robotic micro-manipulators may have more degrees of freedom including rotation control orientation and thus can be used to manipulate objects from 0D (symmetric spheres) to 3D objects in 3D space.

4. STUDY ON MANIPULATION AND BIO-MANIPULATION MICRO-SYSTEMS

4.1. Micro-nano-robotic Manipulators

Nano-robotic micro-manipulators are the basic components of micro-nano-robotic handling systems. The basic requirements for a micro-handling system for handling nano-robots includes resolution positioning at 3D micro-nano-scale, a large enough work space, enough degrees of freedom including those for of rotation for 3D positioning and orientation control effectors and general multiple effectors for complex operations.

A commercially available micro-nano-manipulator installed inside an SEM is shown in Figure 20.

Tabe1 presents the system specifications. The

manipulator has three degrees of freedom and resolution of under micro-nano-scale (table 2).

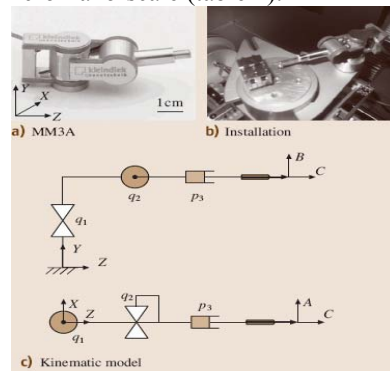

Fig.21

Table 1

Element	Specification
Operation range: $q_1$ and $q_2$	240°
Operation range: Z	12 mm
Resolution: A (horiz.)	10 <sup>-7</sup> rad (5 nm)
Resolution: B (vert.)	10 <sup>-7</sup> rad (3.5 nm)
Resolution: C (linear)	0.25 nm
A fin range (scanning)	20 μm
B fin range (scanning)	15 μm
IC fin range (scanning)	1 μm
A, B Speed	10 mm/s
C Speed	2 mm/s

Calculation show that, when it moves/scanns in the A/B direction through the  $q_1/q_2$  connection, the extra linear displacement in C is very little. For example, when the displacement of the arm is 50 nm, the additional displacement in the C direction is of only 0.25-1 nm when it moves in the A direction for 5-10 jam; these errors can be ignored and compensated with an additional displacement of the prism connection P3, that has a resolution of 0.25 nm. In figure 22 a is presented a micro-nano-robotic manipulation system with 16 total degrees of freedom (DOFs) and can be equipped with four AFM peaks with effectuators both for manipulation and for measurement.

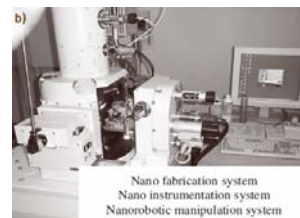

Fig. 22 a,b. Nano-robotic System. (a) Nano-robotic manipulators, (b) Composition of the system

Table 2

Element	Specification
<b>Micro-nano-robotic manipulation system</b>	
DOFs	Total: 16 DOFs
	Unit 1: 3 DOFs (x, y and p; rough)
	Unit 2: 1 DOF (z; brut), 3-DOF (x, y, and z; pure)
	Unit 3: 6 DOFs (x, y, z, a, p, y; ultrapure)

Element	Specification
Actuators	4 Pico engines (Units 1 & 2)
	9 PZTs (Units 2 & 3)
	7 Nano-engines (Units 2 & 4)
Final effectors	3 AFM consoles + 1 sub-layer or
	4 AFM consoles
Work space	18 mm x 18 mm x 12 mm x 360° (rough, pure)
	26 μm x 22 μm x 35 μm (ultra-pure)
Positioning resolution	30 nm (rough), 2 mrad (rough), 2 nm (pure), sub-nm (ultra-fine)
Detection system	FESEM (resolution: nm) and AFM console
<b>Micro-nano-instrumentation system</b>	
FESEM	Resolution: 1.5 nm
AFM console	Stiffness constant 0.03 nN/nm
<b>Micro-nanofabrication System</b>	
EBID	FESEM Emitter: T-FE
	CNT Emitter

## 4.2. Robotic Bio-manipulation

### 4.2.1 Robotic bio-manipulation application

**The bio-manipulation is the autonomous robotic injection of the DNA pro-nuclei:**

To improve the low success rate of manual operation and to eliminate contamination, an autonomous robotic system (shown in Fig. 23) was developed in order to submit a DNA in the two nuclei of an embryo without causing cell damage. Experimental results show the successful laboratory for autonomous DNA injection in the pro-nucleus is improved considerably compared to conventional injection methods. The autonomous robotic system includes a hybrid controller that combines visual and precision position control, pattern recognition scheme to detect nuclei and precise auto-focus.

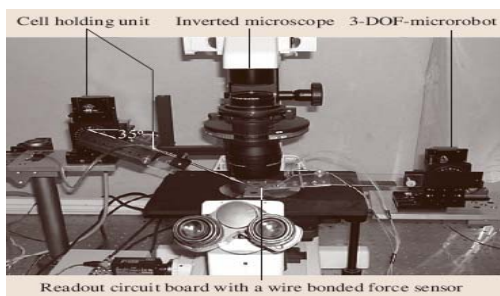

**Fig. 23** System for nano-robotic bio-manipulation with image and reaction force

Figure 24 illustrates the injection process.

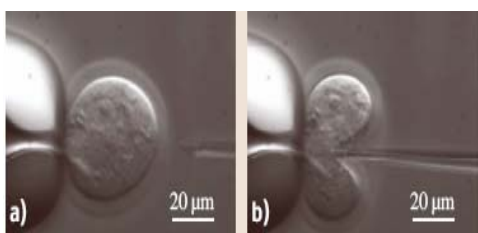

**Fig. 24.** The injection process. (a,b) Cellular injection

## 5. STUDY ON INTEGRONIC INTEGRONICS AND INTELLIGENT ROBOTS

### 5.1. Generality

Integronic robotics is an integronic field in which integronic robots action and interact in various „scenarios" with technical, scientific, biological, geographical, geological, productive, astronomical, military, mathematic, physical, informatic processes etc in simple to complex processes in phases adapted to the scopes in the environment.

Integronic robotics links unitary and systemically the structural scientific, mechanic, electronic, informatic, social, psychological, economic universe and so on that works together friendly with the environment and man for the production of material goods and developing activities that are integrated and/or complementary to the existence if life.

Approaching and disseminating integronic robotics supposed a complex understanding of the behaviours as a whole in the endowment and realization of integronic plants as concrete parts of a future integronic industry. In essence, integronic robotics accumulates as a whole the technical and technological robot, the automation and informatization, the artificial and neuronal sciences, the sciences of physics, chemistry and mathematics, the social, psychological and economical aspects. the managing, coordinating and monitoring management, as protection and environmental care elements.

The evolution of robotic integronics. began to know the first steps of the first generation integronics as: programmable on-line and off-line robotics, integrated with sensors, actuators, artificial intelligence and neural network command monitored psycho-socio-economically, adaptive robotics integrating heuristics of "superhuman intellectual capacity and versatile" multi-vector gene integrated robotic "capacity of fuzzyfication".

### 5.2. Constructive and functional concept for nano-robotics and integronic robotics integronics

**Command micro-nano-systems** for integronic robotics are approached either in an open loop, in a **kinematic/actioning/decision loop:** integronic command system / micro-system → integronic actioning system / micro-system → integronic mechanic system / micro-system → integronic representation system / micro-system → integronic evaluation system / micro-system → environment, either in a close loop in the mentioned command/actioning/adaptive actioning action, with feedback from the components of the kinematic chain, through measuring devices / equipments, sensors/ micro-nano-sensors and through transducers/micro-nano-transducers.

**The architecture of the integronic command system/micro-nano-system** of the integronic robotic can be expressed in the following scheme (fig.25), where the border of the command system / micro-nano-system in correlation with other integronic command

systems/micro-nano-systems for the evaluation, command and automated and informational regulation of the processes/micro-nano-processes followed/served by the flexible industrial production.

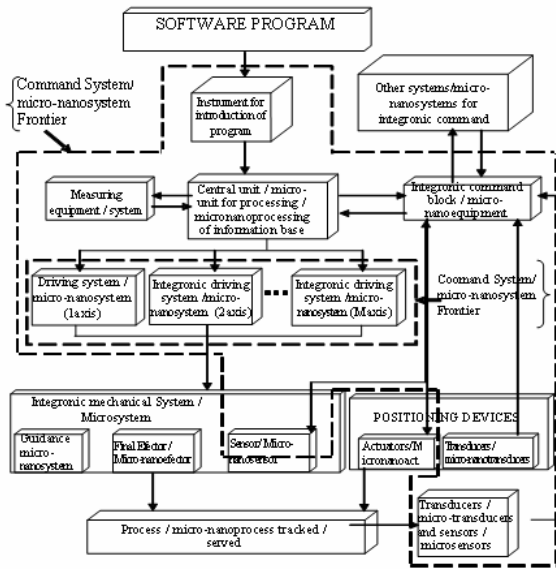

Fig.25

## 6. STUDY ON THE SPECIAL APPLICATIONS OF MICRO-NANOROBOTICS AND INTEGRONIC ROBOTICS

### 6.1. Medical Mechatronic Application

Micro-nano-robotics applications developed more than in any other area, in the Medical Mechatronics, which is needed in micro-nano-devices, capable of a certain autonomy and penetration in the area affected by injection, drip, inhalation or massage at skin or muscles. In the in-situ process, nano-robots are introduced into the human body to detect tissue or cell of interest and identified displacement area, following the positioning and fixation on the area or near it.

In the process of investigation, nano-robots are placed into the human body in interest areas and must determine and record certain parameters or parameter values to be communicated to the tracking environment, for making a correct diagnosis. In the process of intervention and treatment, nano-robots use all the human body, and after the doctor made a diagnosis, they had to intervene mechanically, chemically, electrically, magnetically or using laser on diseased tissues and even on cells or viruses or use the pathogen bacteria. In nano-robots, the doctor inserts the nano-robot in the area of interest and constantly supervises it

The nano-robot, through its dedicated software, allows the communication with the environment and at the same time, the physician can take certain action decisions on the limits imposed by the physician or by its designer. The nano-robot collects the information needed from the interest area and according to the decision of the physician, it commands the actioning elements and the nano-robot can intervene over the troubled tissue or cells in the body of the patient

In the world, there are many nano-robots realized for the field, such as „Centre for Automation in Nano-biotech” in Sao Paolo, Brazil.

In the figures below (fig.26; fig.27; fig.28) are shown nano-robots in action.

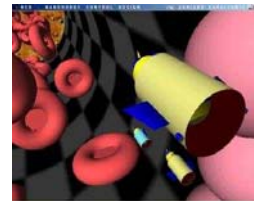

Fig 26

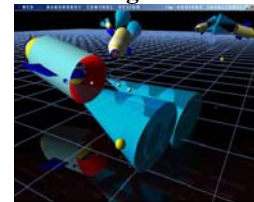

Fig. 27

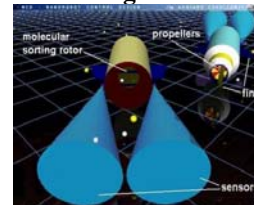

Fig.28

## 7. STUDY, RESEARCHES AND APPLICATIONS OF ROBOTIC HEXAPOD MICRO-SYSTEM FROM MEMS AND NEMS LABORATORY - INCDMTM

### 7.1. Description of micro-robotic system

Micro-robotic hexapod system (fig. 29) consists of a micromechanical subsystem, mobile platform supported by six linear actuators, drives, controller, PC and software.

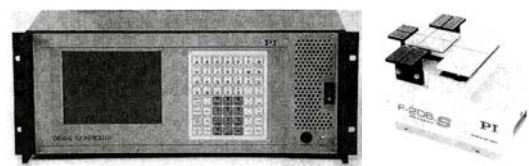

Fig.29

All orders for positioning platform of the robotic system are given in orthogonal coordinates and converted by the controller into specific positions and speeds associated with the robotic system.

With integrated micro-programs / software update option, the controller can be configured to control additional axes.

With updating integrated micro-programs / software, robotic system can command axis (K, L and M) and piezo-positioners compatible with the controller(E-760 ).

### 7.2. Hexapod robotic system

#### 7.2.1 Mechanical part design

Robotic system design is based on parallel kinematics and parallel metrology design with actuators that drive constant lengths bars which are mounted above the actuators for transferring the motion to the mobile platform.

The advantages of this designs are low weight, high rigidity, 6-axis motion, high resolution and without cables to move or to determine the drag or friction. In figure 30 is presented kinematical structure with parallel linear actuators and connecting levers, of constant length.

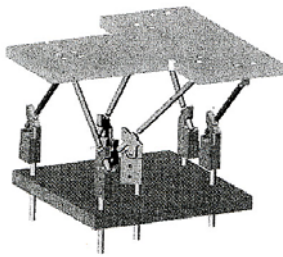

Fig.30

### 7.2.2 Synchronizing the displacement of the 6-axis robotic system

When the electronic part is leading the platform along the axes or around a fixed pivot point, all six actuators must move harmonized through complex interpolations, which guides the platform along the desired trajectory.

All commands for displacement are referring to the platform position defined by three values of rotation and three linear coordinates.

Axes on which rotations are defined (U, V and W) coincide with the initial XYZ coordinate system of the robotic system. Their pivotal intersection materializes point that can be moved by a control operator and can be placed inside or outside the workspace.

Displacements that specify new parameters X, Y or Z (translation) can also move the pivot point (eg moving the pivot point to platform). Similarly a non-zero rotation around the X (motion-U) rotates the axes of rotation V and W and a non zero rotation around Y (parameter V) axis rotates W. This means, for example, that the motion W always rotates the platform around a perpendicular lane on its plane.

To execute a motion command, the system first evaluates the target specification for the position, and then calculates how to get there from the current position with a smooth motion vector, and then execute the displacement.

### 7.3. The coordinate system of the hexapod robotic system.

#### 7.3.1 The definitions of translation and rotation axis of the hexapod robotic system.

Translations (linear displacements) are all measured against the position of the platform after an INI command. Angular motions are pivot around the point. If the pivot value is (0,0,0) is located relative to the platform as shown in Fig. 31.

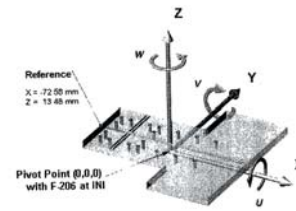

Fig.31

#### 7.3.2. Workspace of hexapod robotic system

Workspace XYZ depends on U, V and W coordinates values as shown in Figure 32 and Figure 33.

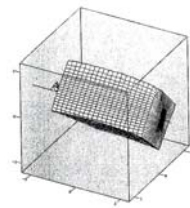

Fig.32

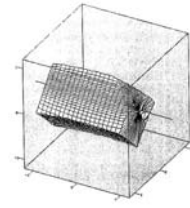

Fig.33

### 8. REFERENCES

- [1]. Brugger, J. et al. „Microfabricated tools for nanoscience”, Journal of Micromechanics and Microengineering, 1993 (4), Vol. 3, pp 161-167.
- [2]. Considine, Douglas M. & Considine, Glenn, D.: „Process Instruments and controls handbook”, 1985, New York, USA.
- [3]. Craig J. introduction to Robotics, Mechanics and Control” Stanford University. Addison - Wesley Publishing Company, 1986.
- [4]. Dorsam, Th., Fatikow, S. and Streit, I. "Fuzzy-Based Grasp-Force-Adaptation for Multifingered Robot Hands". Proc. Of the 3rd IEEE World Congress on Computational Intelligence, Orlando, Florida, 1994, pp. 1468-1471.
- [5]. Fatikax, S.; Rembold, U., Tehnologia sistemelor și microrobotică”, Ed. Tehnică, 1999.
- [6]. Gheorghe, I. Gh. "Micronic, sub-micronic and nanomicronic precision metrological micro-technologies", XX Anniversary International Scientific-and-Technological Conference "Extreme Robotics. Nano-, Micro- And Macrorobots", ER-2009, Rusia.
- [7]. Gheorghe, I. Gh. „Micronic, sub-micronic and nanomicronic precision metrological micro-technologies" -17th Annual International Conference on Composites or Nano Engineering, ICCE-17 WAIKIKI, HONOLULU, Conference July 26 - August 1, 2009 in Honolulu, Hawaii, USA.
- [8]. Gheorghe, I. Gh. Pau, V. intelligent Microengineering" The 20th International DAAAM SYMPOSIUM - Intelligent Manufacturing & Automation: Theory, Practice & Education, 25-28th November 2009, Vienna, Austria.
- [9]. Gheorghe I. Gh. „Mecatronă integrată - integronica" - 2003 - ISBN 973-99591-0-5 | 973 - 99591-8-0.